



METRO

shower book



 impresa



The embodiment of
contemporary form
and purpose

A tileable, integrated channel-drain shower base.
Single-plane base allowing easy tile application
all-the-while providing vital protection.

Install the base onto a bathroom floor
or recess flush with the bathroom floor.

Suitable Concrete or Timber floors.

Impresa...Custom or Standard showers

PLATINUM
GUARANTEE

25
YEARS

LEAKPROOF



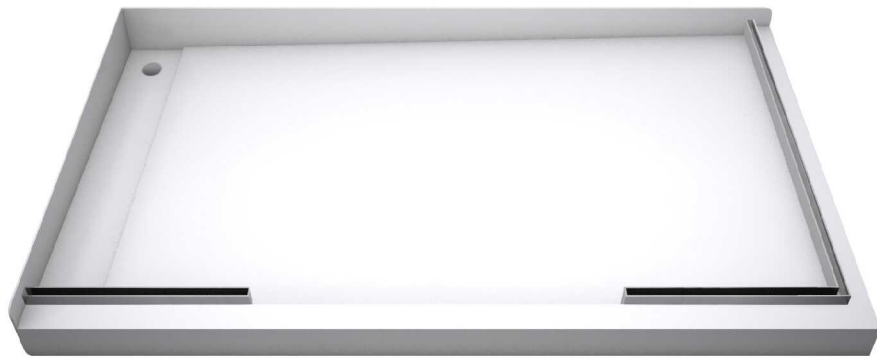

Tray Specifications

- Material: One-piece, 3mm-thick epoxy-coated, marine-grade aluminium
- CNC-cut and folded -- accurate to the millimetre
- Correct drainage-gradients designed into tray
- Double-welded inside and outside ensuring a 100% leakproof tray
- Tray reinforced with GRP
- Supported on high-density moulded pads
- Glazing channels factory-attached to tray internal area
- Easy-Clean Waste-trap included
- Ready to tile
- Custom Sizes and options available
- Standard Sizes 160-plus
- Install On-Floor or Rebated Level-Entry
- Platinum 25-Year Leakproof Guarantee

NZ Design Registration No.
412658, 412659, 412660,
416340, 416341, 416342, 416343,
419849, 419850, 419851, 419852

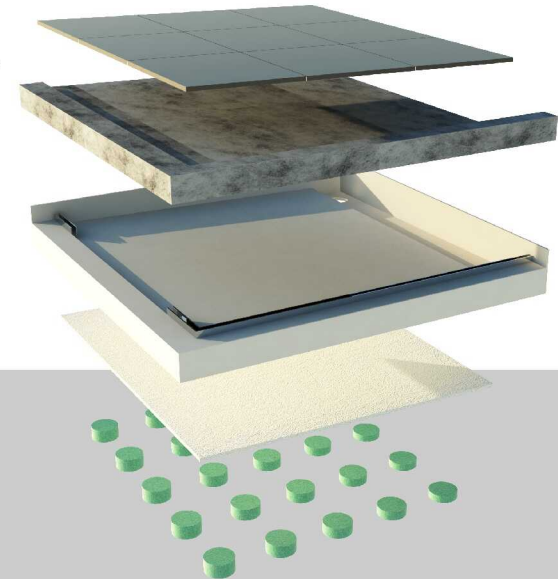



Channel Cover / Grate Options

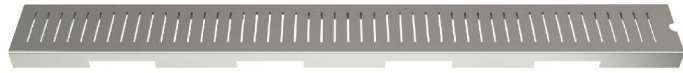

Slotted Stainless-steel Cover



Solid-Top Stainless-steel Cover



Tileable Cover



Wedge-Wire Grate

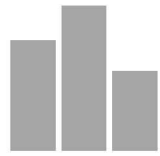

METRO

Frameless-Glass Enclosure

Standard Height: 2000mm off tray. Optional heights available

Thickness: 10mm Tempered / toughened safety-glass

Compliant to NZS 4223:2016 / AS/NZS 2208:1996

Integrated Enclosures -- Hinged Door, Sliding Door, Walk-thru options.

Standard or Low-iron Ultra-clear Glass; Frosted glass options

.Glazing Channels: Matte aluminium, Brushed aluminium, 'Chrome Finish',

Black , Gunmetal finishes

Hinges: Quality chromed brass. Self-Centring.

Handle: Standard -- Round 'D' (polished stainless-steel).

Optional handles available.

Warranty: Glass 10 Years. Hardware 5 Years.



Handle Options



Round D



Square D



Round H



Square H



Square Pull

Finishes and Colours

Chrome

Brushed Chrome

Brushed Nickel

Satin Black

Gunmetal

Hinge Options



Chrome



Brushed
Chrome



Brushed
Nickel



Gun Metal



Satin Black

See corresponding Handle and Channelling options

Custom Showers

Get a Quote

Call (09) 273 4545 or
email to sales@impresa.co.nz

Ordering

To order, visit the website
Custom page, print the
appropriate Worksheet PDF
and provide the required
info. Email the worksheet
forms to sales@impresa.co.nz

Impresa is acknowledged by architects and builders throughout NZ as the industry leader of custom-manufactured tileable and stainless-steel shower systems. We welcome discussion with all homeowners, designers, and trades throughout the process of shower design and installation.

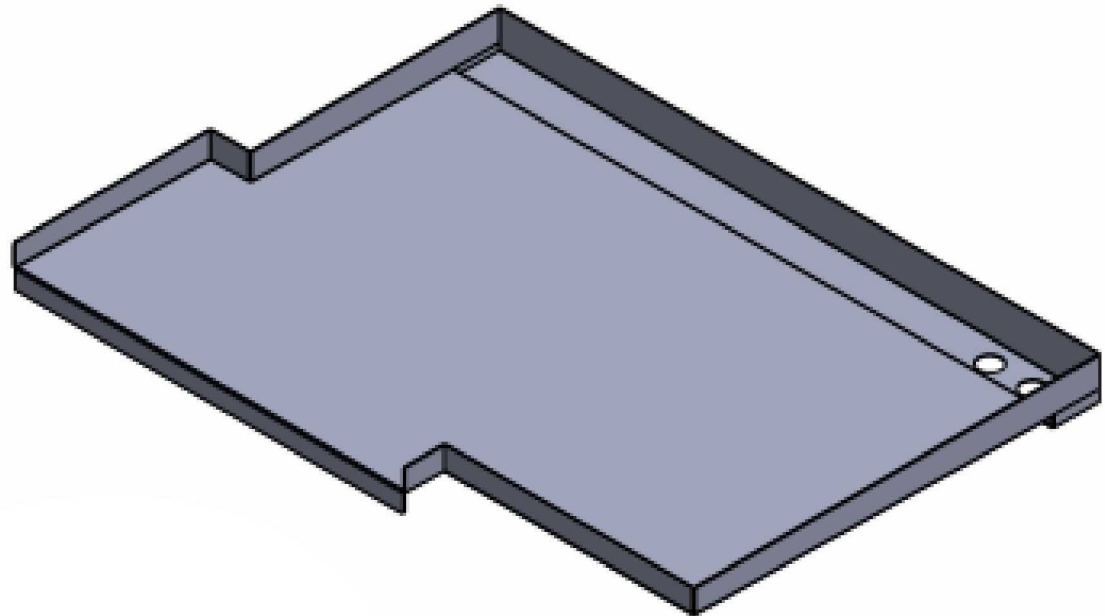



METRO SPECIFICATIONS

SHOWER BASE / TRAY

One-piece / 3mm-thick marine-grade / epoxy-coated aluminium
Single-plane slope to integral channel-drain at tray rear, left or right side
Fibreglass-reinforced underside and support pads

Glazing Channelling

Standard: Matte Aluminium finish. Optional: Bright Chrome finish
Black powder-coated as quoted. Factory-installed to tray internal area

STANDARD SIZES: 160 plus. **CUSTOM SIZES** / waste-outlet positions

ON-FLOOR TRAY

Threshold height 50mm minimum. Threshold width 50mm.
Installation onto timber or concrete floor.

LEVEL-ENTRY TRAY

Designed with 15mm step-down
Installation onto rebated timber or concrete floor

WHEELCHAIR-ACCESS TRAY

True, flush-entry (no step-down)
Installation onto rebated timber or concrete floor

WASTE AND EASY-CLEAN TRAP OPTIONS

Chromed Brass Waste: 40mm Dia. Inlet / Outlet (requires P or S Trap)
ABS Waste: 90mm Inlet / 50mm Dia. Outlet (requires P or S Trap)
ABS Easy-Clean Trap: 90mm Inlet / 50mm Outlet
PP Easy-Clean Trap: 40mm Inlet / 40mm Outlet

CHANNEL-DRAIN COVER / GRATE OPTIONS

(A) Stainless-steel -- solid top surface
(B) Stainless-steel -- slotted top surface
(C) Stainless-steel -- Tileable cover
(D) Stainless-steel -- Wedge-Wire (optional)

FRAMELESS-GLASS ENCLOSURE

Thickness: 10mm tempered / toughened safety glass
Standard Height: 2000mm (Optional Heights available)
NZS4223.3:2016 / AS/NZS 2208:1996 Compliant
Hinged door. Sliding door or 'Walk-In' panel-only options
Glazing Channel -- Matte Aluminium-finish standard supply
Bright Chrome standard as requested
Black powder-coated -- optional as quoted
Hinges -- Standard: Chromed brass
Optional: Brush stainless-steel or Black powder-coated
Handles -- Standard: 'Round D' Polished stainless-steel
(Optional handles available)

LIQUID-APPLIED WALL WATERPROOFING MEMBRANES

Supplied by tiler or waterproofing sub-contractor.
See Recommended Waterproofing and Membranes list.

INSTALLATION

Tray to be installed with polymer-modified tile adhesive.
See Recommended Adhesives list. Impresa recommends the enclosure is installed by an experienced frameless-glass installer.

WARRANTY

Shower Tray: 25-years
Frameless-Glass Enclosure: 10-years
Hardware: 5-years
See Warranty Statement



Impresa Tile Showers Ltd.

W: impresa.co.nz E: support@impresa.co.nz P: 09 273 4545



Level-Entry with Step-down.

Timber Floor Installation

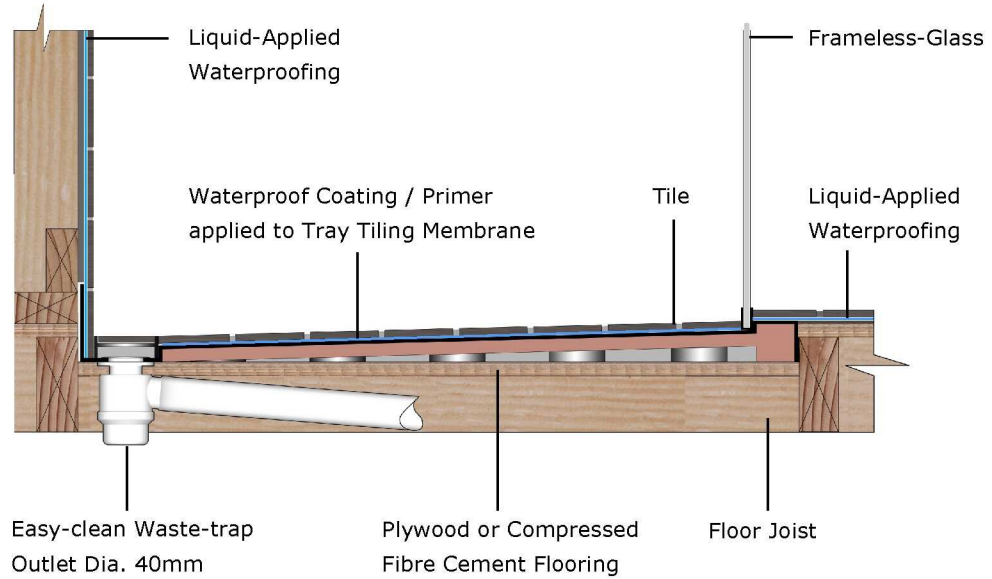

On-Floor with Threshold.

Timber Floor Installation

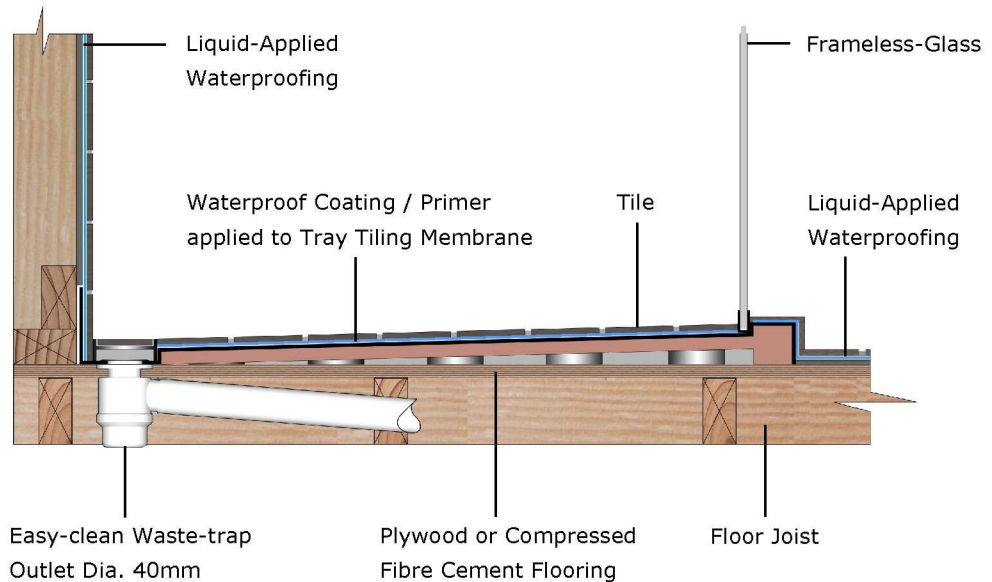

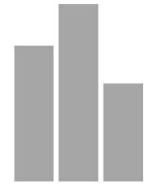

METRO

STANDARD SIZES LIST



alcove shower

TRAY OPTIONS

(A) 'On-Floor' with Threshold

(B) 'Level - Entry' with Step

(C) 'Wheelchair-Access' Flush-Entry

GLASS ENCLOSURES

See Tray and Glass Enclosures pages

ORDERING STANDARD SIZES

Provide code number below of required tray size and channel-drain location for On-Floor / Level-Entry trays.

'Wheelchair' trays must have a Rear Channel Drain. Add 'W' to Rear Channel code below for Wheelchair tray option.

Add 'L' for Left-hand waste-outlet hole position / 'R' for Right-hand waste-outlet hole position / 'C' for centred waste-outlet hole position.

TRAY SIZE	REAR CHANNEL	LEFT-HAND CHANNEL	RIGHT-HAND CHANNEL
	CODE NO.	CODE NO.	CODE NO.
900 x 900	MA9090R	MA9090LH	MA9090RH
950 x 900	MA9590R	MA9590LH	MA9590RH
1000 x 900	MA10090R	MA10090LH	MA10090RH
1050 x 900	MA10590R	MA10590LH	MA10590RH
1100 x 900	MA11090R	MA11090LH	MA11090RH
1150 x 900	MA11590R	MA11590LH	MA11590RH
1200 x 900	MA12090R	MA12090LH	MA12090RH
1250 x 900	MA12590R	MA12590LH	MA12590RH
1300 x 900	MA13090R	MA13090LH	MA13090RH
1350 x 900	MA13590R	MA13590LH	MA13590RH
1400 x 900	MA14090R	MA14090LH	MA14090RH
1450 x 900	MA14590R	MA14590LH	MA14590RH
1500 x 900	MA15090R	MA15090LH	MA15090RH
1550 x 900	MA15590R	MA15590LH	MA15590RH
1600 x 900	MA16090R	MA16090LH	MA16090RH
1650 x 900	MA16590R	MA16590LH	MA16590RH
1700 x 900	MA17090R	MA17090LH	MA17090RH
1750 x 900	MA17590R	MA17590LH	MA17590RH
1800 x 900	MA18090R	MA18090LH	MA18090RH
1850 x 900	MA18590R	MA18590LH	MA18590RH
1900 x 900	MA19090R	MA19090LH	MA19090RH
1950 x 900	MA19590R	MA19590LH	MA19590RH
2000 x 900	MA20090R	MA20090LH	MA20090RH

TRAY OPTIONS

(A) 'On-Floor' with Threshold

(B) 'Level - Entry' with Step

(C) 'Wheelchair-Access' Flush-Entry

GLASS ENCLOSURES

See Tray and Glass Enclosures pages

ORDERING STANDARD SIZES

Provide code number below of required tray size and channel-drain location for On-Floor / Level-Entry trays.

'Wheelchair' trays must have a Rear Channel Drain. Add 'W' to Rear Channel code below for Wheelchair tray option.

Add 'L' for Left-hand waste-outlet hole position / 'R' for Right-hand waste-outlet hole position / 'C' for centred waste-outlet hole position.

TRAY SIZE	REAR CHANNEL	LEFT-HAND CHANNEL	RIGHT-HAND CHANNEL
	CODE NO.	CODE NO.	CODE NO.
900 x 1000	MA90100R	MA90100LH	MA90100RH
950 x 1000	MA95100R	MA95100LH	MA95100RH
1000 x 1000	MA100100R	MA100100LH	MA100100RH
1050 x 1000	MA105100R	MA105100LH	MA105100RH
1100 x 1000	MA110100R	MA110100LH	MA110100RH
1150 x 1000	MA115100R	MA115100LH	MA115100RH
1200 x 1000	MA120100R	MA120100LH	MA120100RH
1250 x 1000	MA125100R	MA125100LH	MA125100RH
1300 x 1000	MA130100R	MA130100LH	MA130100RH
1350 x 1000	MA135100R	MA135100LH	MA135100RH
1400 x 1000	MA140100R	MA140100LH	MA140100RH
1450 x 1000	MA145100R	MA145100LH	MA145100RH
1500 x 1000	MA150100R	MA150100LH	MA150100RH
1550 x 1000	MA155100R	MA155100LH	MA155100RH
1600 x 1000	MA160100R	MA160100LH	MA160100RH
1650 x 1000	MA165100R	MA165100LH	MA165100RH
1700 x 1000	MA170100R	MA170100LH	MA170100RH
1750 x 1000	MA175100R	MA175100LH	MA175100RH
1800 x 1000	MA180100R	MA180100LH	MA180100RH
1850 x 1000	MA185100R	MA185100LH	MA185100RH
1900 x 1000	MA190100R	MA190100LH	MA190100RH
1950 x 1000	MA195100R	MA195100LH	MA195100RH
2000 x 1000	MA200100R	MA200100LH	MA200100RH

GLASS THICKNESS: 10mm

GLASS HEIGHT: 2000mm. Custom Height Optional

DOOR STANDARD WIDTHS: 600, 650, 700mm. Custom Width Optional

DOOR POSITION: Centred or Off-centre as shown

CHANNEL DRAIN POSITION: As shown by dotted lines

WASTE HOLE POSITION: End of channel or centre.
Custom position optional.

ALCOVE TRAY

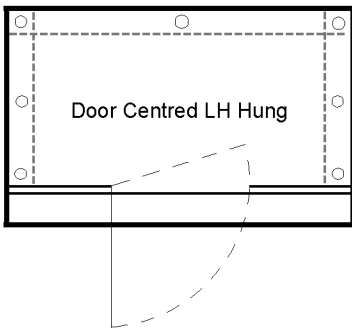

Enclosure O

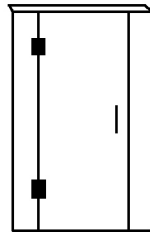

Enclosure P

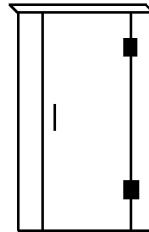

ALCOVE TRAY

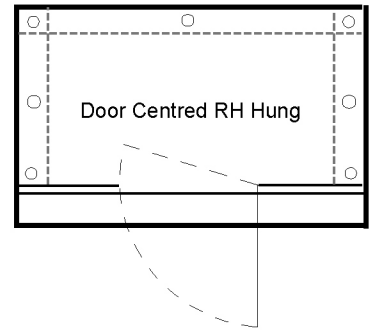

ALCOVE TRAY

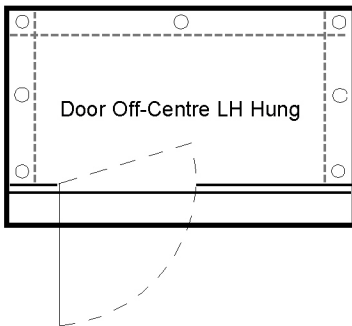

Enclosure Q

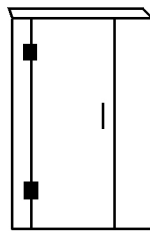

Enclosure R

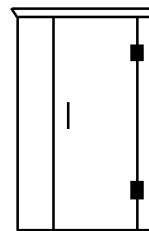

ALCOVE TRAY

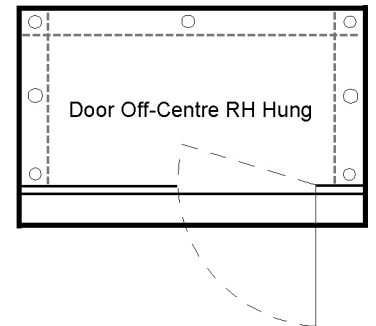

ALCOVE TRAY

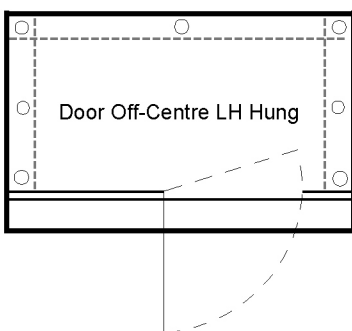

Enclosure S

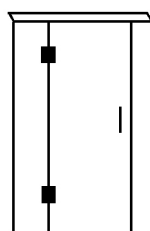

Enclosure T

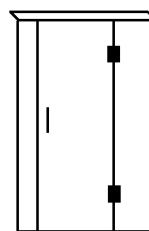

ALCOVE TRAY

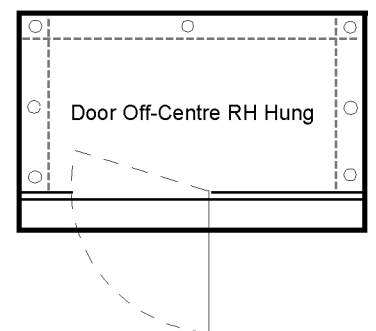

'WALK-THRU' SHOWER

GLASS THICKNESS: 10mm

GLASS HEIGHT: 2000mm. Custom Height Optional

WALK-THRU OPENING WIDTH: 600-800mm

GLASS PANEL LENGTH / WIDTH: As required

CHANNEL DRAIN POSITION: As shown by dotted lines

WASTE HOLE POSITION: End of channel or centre.

Custom position optional.

ALCOVE TRAY

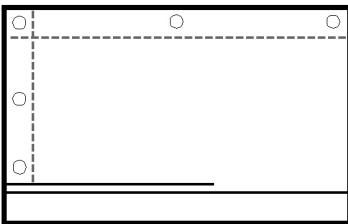

Enclosure 1PL

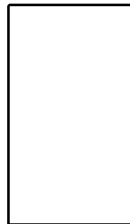

Enclosure 1PR



ALCOVE TRAY

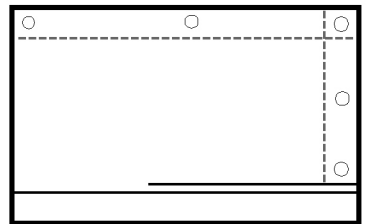

ALCOVE TRAY

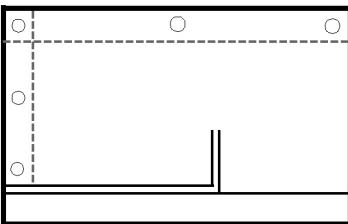

Enclosure 2PL

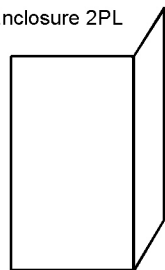

Enclosure 2PR

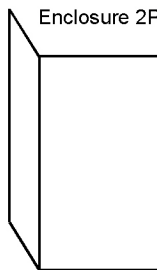

ALCOVE TRAY

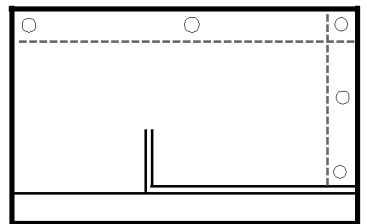

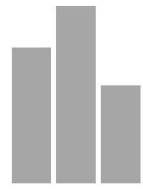

METRO

STANDARD SIZES LIST



corner shower



CORNER TRAY STANDARD SIZES

TRAY OPTIONS (A) 'On-Floor' with Threshold

(B) 'Level - Entry' with Step

GLASS ENCLOSURES

See Tray & Glass Enclosures pages

ORDERING STANDARD SIZES

Provide code number below of required tray size / channel-drain position for On-Floor and Level-Entry trays.

Add 'L' for Left-hand waste-outlet hole position / 'R' for Right-hand waste-outlet hole position / 'C' for centred waste-outlet hole position.

TRAY SIZE	LEFT-HAND TRAY LEFT-HAND CHANNEL CODE NO.	LEFT-HAND TRAY REAR CHANNEL CODE NO.	RIGHT-HAND TRAY REAR CHANNEL CODE NO.	RIGHT-HAND TRAY RIGHT-HAND CHANNEL CODE NO.
900 x 900	MC9090LL	MC9090LRR	MC9090RRR	MC9090RR
950 x 950	MC9595LL	MC9590LRR	MC9595RRR	MC9595RR
1000 x 900	MC10090LL	MC10090LRR	MC10090RRR	MC10090RR
1050 x 950	MC10595LL	MC10595LRR	MC10595RRR	MC10595RR
1000 x 1000	MC100100LL	MC100100LRR	MC100100RRR	MC100100RR
1050 x 1050	MC105105LL	MC105105LRR	MC105105RRR	MC1051050RR
1100 x 900	MC11090LL	MC11090LRR	MC11090RRR	MC11090RR
1100 x 1000	MC110100LLR	MC110100LRR	MC110100RRR	MC110100RR
1100 x 1100	MC110110LL	MC110110LRR	MC110110RRR	MC110110RR
1200 x 900	MC12090LL	MC12090LRR	MC12090RRR	MC12090RR
1250 x 950	MC12595LL	MC12595LRR	MC12595RRR	MC12595RR
1200 x 1000	MC120100LL	MC120100LRR	MC120100RRR	MC120100RR
1200 x 1200	MC120120LL	MC120120LRR	MC120120RRR	MC120120RR
1400 x 900	MC14090LL	MC14090LRR	MC14090RRR	MC14090RR
1400 x 1000	MC140100LL	MC140100LRR	MC140100RRR	MC140100RR
1500 x 900	MC15090LL	MC15090LRR	MC15090RRR	MC15090RR
1500 x 1000	MC150100LL	MC150100LRR	MC150100RRR	MC150100RR
1600 x 900	MC16090LL	MC16090LRR	MC16090RRR	MC16090RR
1600 x 1000	MC160100LL	MC160100LRR	MC160100RRR	MC160100RR
1800 x 900	MC18090LL	MC18090LRR	MC18090RRR	MC18090RR
1800 x 1000	MC180100LL	MC180100LRR	MC180100RRR	MC180100RR
2000 x 900	MC20090LL	MC20090LRR	MC20090RRR	MC20090RR
2000 x 1000	MC20090LL	MC200100LRR	MC200100RRR	MC200100RR

GLASS THICKNESS: 10mm

GLASS HEIGHT: 2000mm. Custom Height Optional

DOOR WIDTH: 650, 700mm or as required

DOOR POSITION: Centred or Off-centre as shown

CHANNEL DRAIN POSITION: As shown by dotted lines

WASTE HOLE POSITION: End of channel or centre.

Custom position optional

CORNER TRAY: Left-Hand

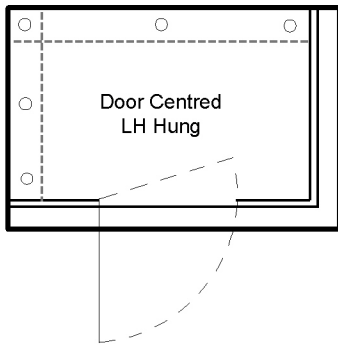

Enclosure A

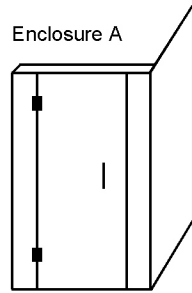

Enclosure B

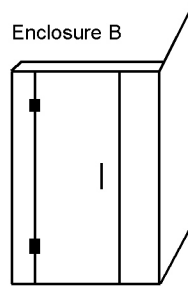

CORNER TRAY: Left-Hand

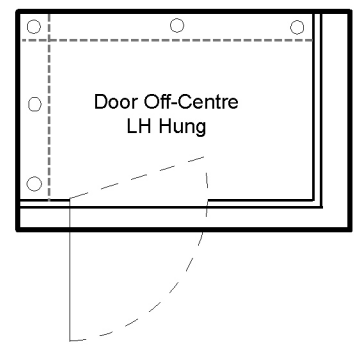

CORNER TRAY: Left-Hand

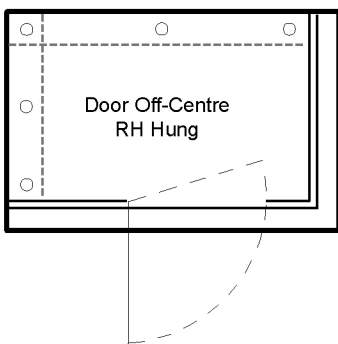

Enclosure C

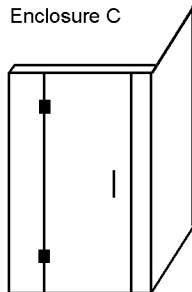

CORNER TRAY: Left-Hand

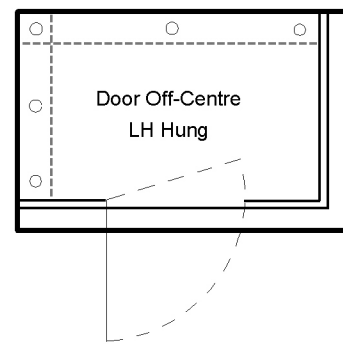

Enclosure D

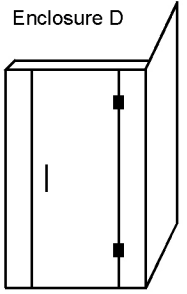

CORNER TRAY: Left-Hand

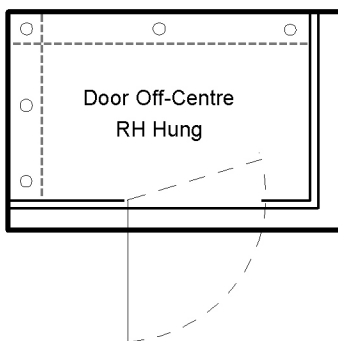

Enclosure E

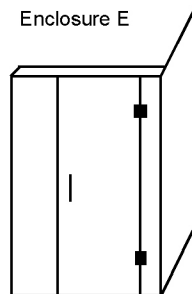

Enclosure F

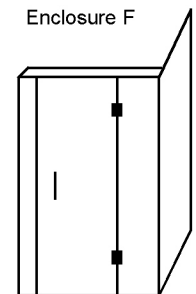

CORNER TRAY: Left-Hand

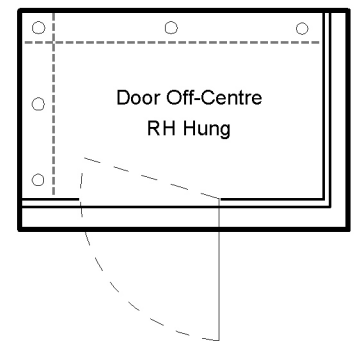

GLASS THICKNESS: 10mm

GLASS HEIGHT: 2000mm. Custom height optional

DOOR WIDTH: 650, 700mm or as required

DOOR POSITION: Centred or Off-centre as shown

CHANNEL DRAIN POSITION: As shown by dotted lines

WASTE HOLE POSITION: End of channel or centre.

Custom position optional.

CORNER TRAY: Right-Hand

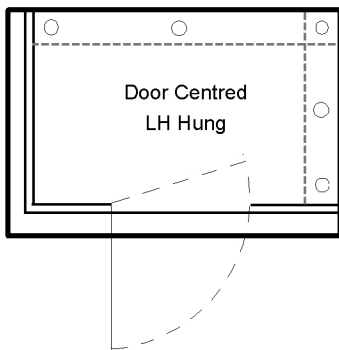

Enclosure G

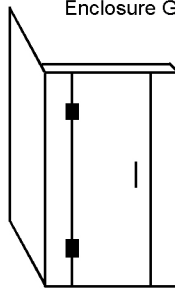

Enclosure H

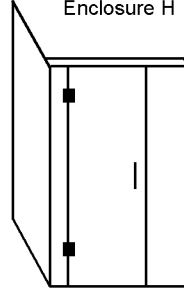

CORNER TRAY: Right-Hand

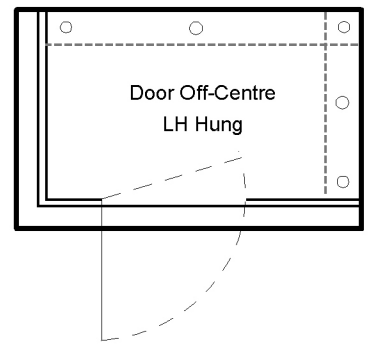

CORNER TRAY: Right-Hand

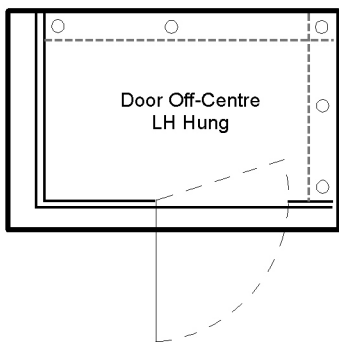

Enclosure I

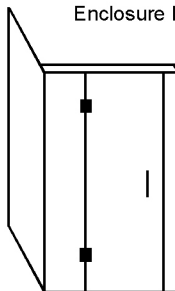

Enclosure J

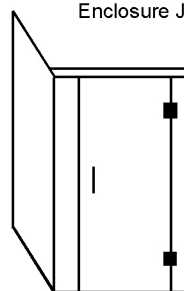

CORNER TRAY: Right-Hand

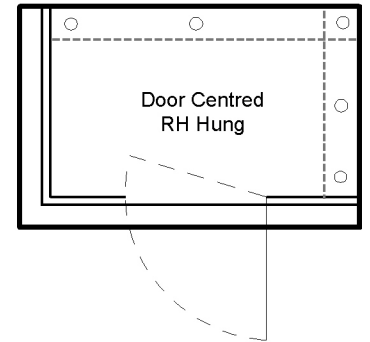

CORNER TRAY: Right-Hand

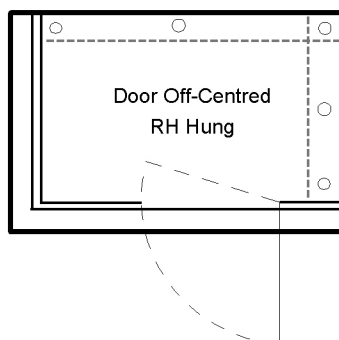

Enclosure K

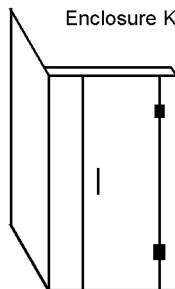

Enclosure L

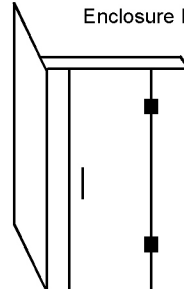

CORNER TRAY: Right-Hand

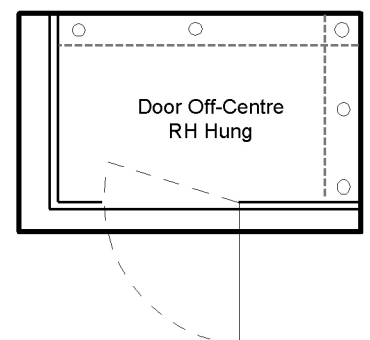

GLASS THICKNESS: 10mm

GLASS HEIGHT: 2000mm. Custom heights optional

DOOR WIDTH: 650, 700mm or as required

DOOR POSITION: Centred or Off-centre as shown

CHANNEL DRAIN POSITION: As shown by dotted lines

WASTE HOLE POSITION: End of channel or centre.

Custom position optional.

CORNER TRAY: Left-Hand

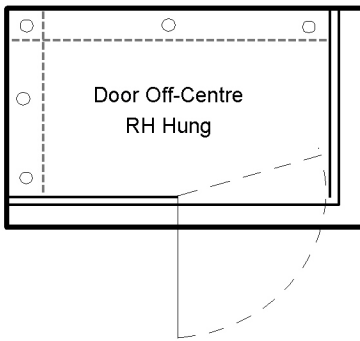

Enclosure M

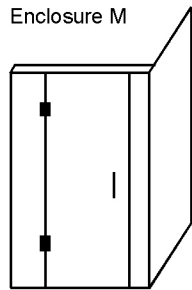

Enclosure N

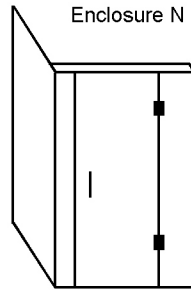

CORNER TRAY: Right-Hand

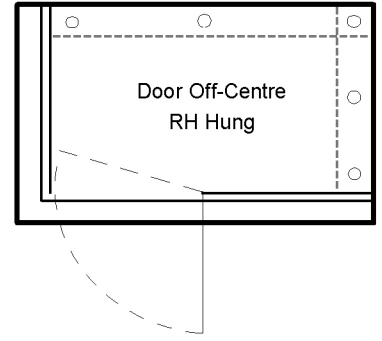

'WALK-THRU' SHOWER

GLASS THICKNESS: 10mm

GLASS HEIGHT: 2000mm. Custom Height optional.

WALK-THRU WIDTH: 600-800mm

RETURN PANEL WIDTH: 200 / 250mm

CHANNEL DRAIN POSITION: As shown by dotted lines

WASTE HOLE POSITION: End of channel or centre.
Custom position optional.

CORNER TRAY: Left Hand

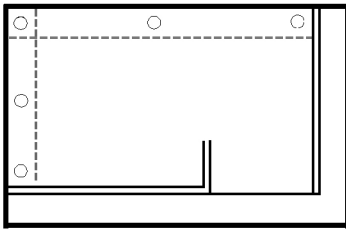

Enclosure 3PL

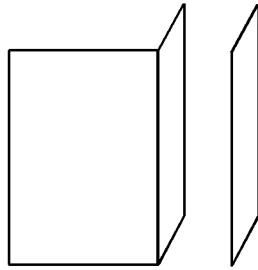

Enclosure 3PR

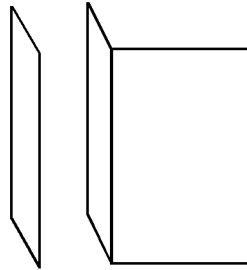

CORNER TRAY: Right Hand

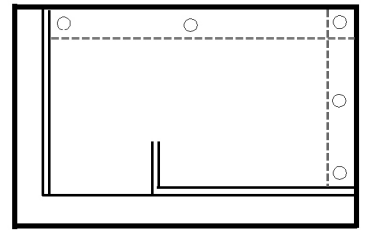

CORNER TRAY: Right Hand

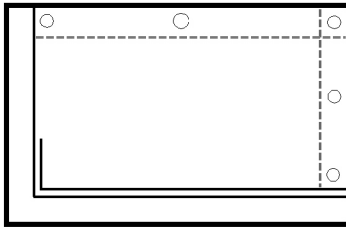

Enclosure 2PL

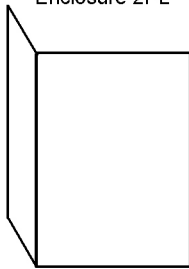

Enclosure 2PR

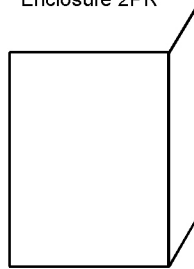

CORNER TRAY: Left Hand

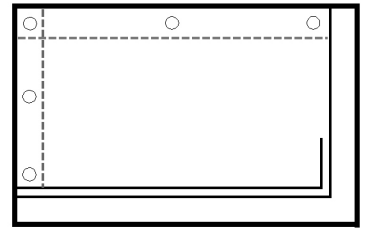

CORNER TRAY: Left Hand

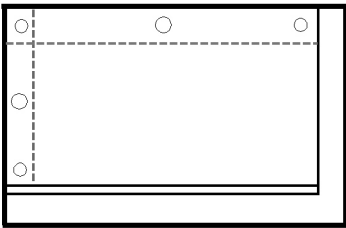

Enclosure PL



Enclosure PR



CORNER TRAY: Right Hand

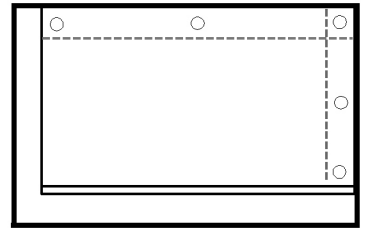

Contact Us

SALES ENQUIRIES

Phone (09) 273 4545

E: sales@impresa.co.nz

W: impresa.co.nz

TECHNICAL ENQUIRIES

Phone (021) 246 8196

email: support@impresa.co.nz

SHOWROOM

81D Cryers Rd.

East Tamaki

Auckland 2013

