



STANDARD SIZES LIST



alcove shower



ALCOVE TRAY STANDARD SIZES

TRAY OPTIONS

(A) 'On-Floor' with Threshold

(B) 'Level - Entry' with Step

(C) 'Wheelchair-Access' Flush-Entry

GLASS ENCLOSURES

See Tray and Glass Enclosures pages

ORDERING STANDARD SIZES

Provide code number below of required tray size / waste-outlet position for On-Floor / Level-Entry trays.

Add 'W' for Wheelchair tray option.

TRAY SIZE	LEFT-REAR WASTE CODE NO.	RIGHT-REAR WASTE CODE NO.	CENTRE WASTE CODE NO.
900 x 900	SA9090L	SA9090R	SA9090C
950 x 900	SA9590L	SA9590R	SA9590C
1000 x 900	SA10090L	SA10090R	SA10090C
1050 x 900	SA10590L	SA10590R	SA10590C
1100 x 900	SA11090L	SA11090R	SA11090C
1150 x 900	SA11590L	SA11590R	SA11590C
1200 x 900	SA12090L	SA12090R	SA12090C
1250 x 900	SA12590L	SA12590R	SA12590C
1300 x 900	SA13090L	SA13090R	SA13090C
1350 x 900	SA13590L	SA13590R	SA13590C
1400 x 900	SA14090L	SA14090R	SA14090C
1450 x 900	SA14590L	SA14590R	SA14590C
1500 x 900	SA15090L	SA15090R	SA15090C
1550 x 900	SA15590L	SA15590R	SA15590C
1600 x 900	SA16090L	SA16090R	SA16090C
1650 x 900	SA16590L	SA16590R	SA16590C
1700 x 900	SA17090L	SA17090R	SA17090C
1750 x 900	SA17590L	SA17590R	SA17590C
1800 x 900	SA18090L	SA18090R	SA18090C
1850 x 900	SA18590L	SA18590R	SA18590C
1900 x 900	SA19090L	SA19090R	SA19090C
1950 x 900	SA19590L	SA19590R	SA19590C
2000 x 900	SA20090L	SA20090R	SA20090C



ALCOVE TRAY STANDARD SIZES

TRAY OPTIONS

(A) 'On-Floor' with Threshold

(B) 'Level - Entry' with Step

(C) 'Wheelchair-Access' Flush-Entry

GLASS ENCLOSURES

See Tray and Glass Enclosure pages

ORDERING STANDARD SIZES

Provide code number below of required tray size / waste-outlet position for On-Floor / Level-Entry trays.

Add 'W' for Wheelchair tray option.

TRAY SIZE	LEFT-REAR WASTE	RIGHT-REAR WASTE	CENTRE WASTE
	CODE NO.	CODE NO.	CODE NO.
900 x 1000	SA90100L	SA90100R	SA90100C
950 x 1000	SA95100L	SA95100R	SA95100C
1000 x 1000	SA100100L	SA100100R	SA100100C
1050 x 1000	SA105100L	SA105100R	SA105100C
1100 x 1000	SA110100L	SA110100R	SA110100C
1150 x 1000	SA115100L	SA115100R	SA115100C
1200 x 1000	SA120100L	SA120100R	SA120100C
1250 x 1000	SA125100L	SA125100R	SA125100C
1300 x 1000	SA130100L	SA130100R	SA130100C
1350 x 1000	SA135100L	SA135100R	SA135100C
1400 x 1000	SA140100L	SA140100R	SA140100C
1450 x 1000	SA145100L	SA145100R	SA145100C
1500 x 1000	SA150100L	SA150100R	SA150100C
1550 x 1000	SA155100L	SA155100R	SA155100C
1600 x 1000	SA160100L	SA160100R	SA160100C
1650 x 1000	SA165100L	SA165100R	SA165100C
1700 x 1000	SA170100L	SA170100R	SA170100C
1750 x 1000	SA175100L	SA175100R	SA175100C
1800 x 1000	SA180100L	SA180100R	SA180100C
1850 x 1000	SA185100L	SA185100R	SA185100C
1900 x 1000	SA190100L	SA190100R	SA190100C
1950 x 1000	SA195100L	SA195100R	SA195100C
2000 x 1000	SA200100L	SA200100R	SA200100C

GLASS THICKNESS: 10mm

GLASS HEIGHT: 2000mm. Custom height optional

DOOR WIDTH: 600, 650, 700mm or as required

DOOR POSITION: Centred or Off-Centre as shown

Sliding Door options not shown -- contact Impresa for details

WASTE OUTLET POSITION

Rear internal corner or Centred.

Custom position optional.

Alcove Tray: Left-Hand

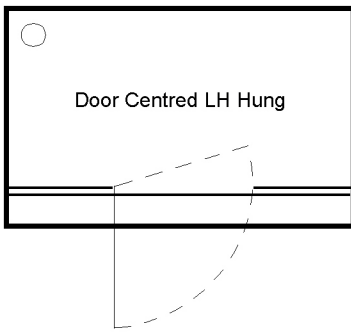

Enclosure O

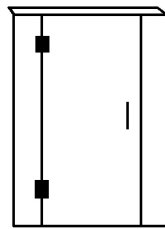

Enclosure P

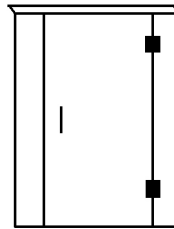

Alcove Tray: Right-Hand

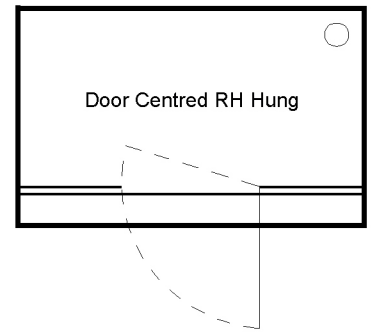

Alcove Tray: Left-Hand

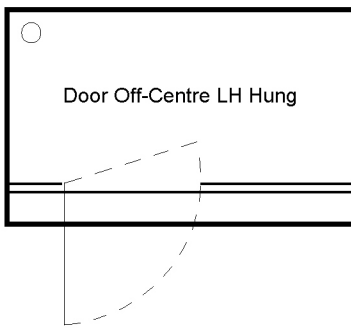

Enclosure Q

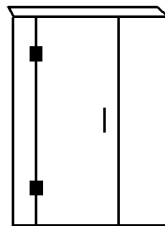

Enclosure R

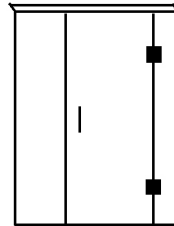

Alcove Tray: Right-Hand

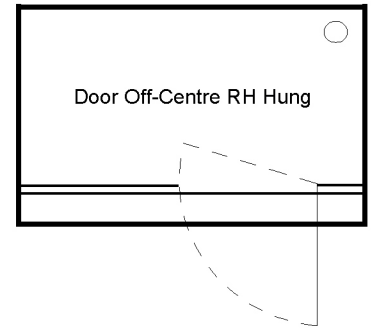

Alcove Tray: Left-Hand

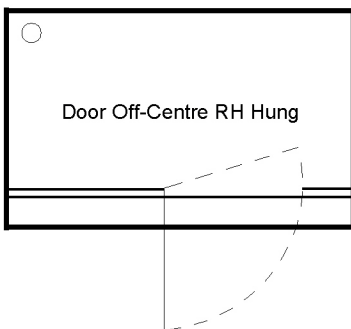

Enclosure S

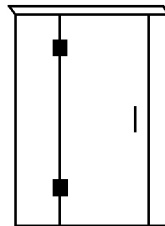

Enclosure T

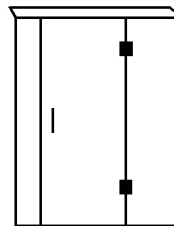

Alcove Tray: Right-Hand

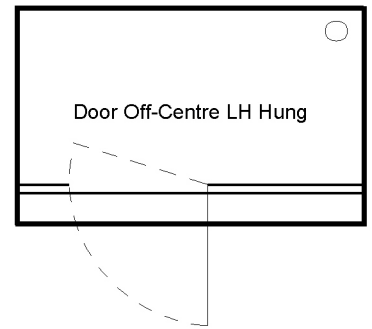

WALK-THRU SHOWER

GLASS THICKNESS: 10mm.

GLASS HEIGHT: 2000mm. Custom Height optional.

Walk-Thru Opening Width: 600-800mm.

WASTE OUTLET POSITION

Rear internal corner or Centred.

Custom position optional.

Alcove Tray: Left-Hand

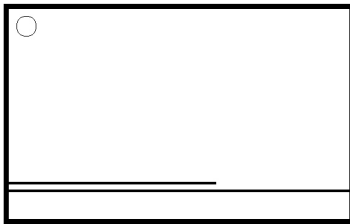

Enclosure: 1PL

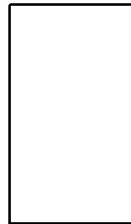

Enclosure 1PR

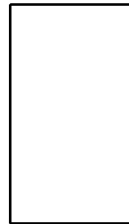

Alcove Tray: Right-Hand

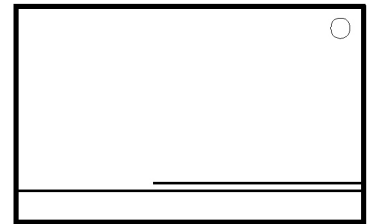

Alcove Tray: Left-Hand

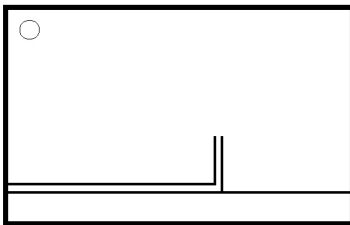

Enclosure 2PR

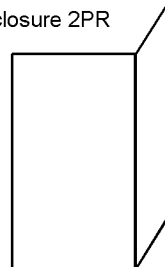

Enclosure 2PL

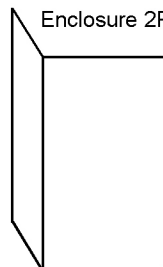

Alcove Tray: Right-Hand

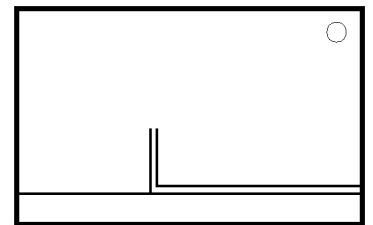

STANDARD SIZES LIST



corner shower



CORNER TRAY STANDARD SIZES

TRAY OPTIONS

(A) 'On-Floor' with Threshold

(B) 'Level - Entry' with Step

(C) 'Wheelchair-Access' Flush-Entry

GLASS ENCLOSURES

See Tray and Glass Enclosure pages

ORDERING STANDARD SIZES

Provide code number of required tray size / waste-outlet position for On-Floor / Level-Entry trays.

Add 'W' for Wheelchair tray option.

TRAY SIZE	LEFT-HAND TRAY LEFT-REAR WASTE CODE NO.	RIGHT-HAND TRAY RIGHT-REAR WASTE CODE NO.	LEFT-HAND TRAY CENTRE WASTE CODE NO.	RIGHT-HAND TRAY CENTRE WASTE CODE NO.
900 x 900	SC9090LL	SC9090R	SC9090LC	SC9090RC
950 x 950	SC9595LL	SC9590RR	SC9595LC	SC9595RC
1000 x 900	SC10090LL	SC10090RR	SC10090LC	SC10090RC
1050 x 950	SC10595LL	SC10595RR	SC10595LC	SC10595RC
1000 x 1000	SC100100LL	SC100100RR	SC100100LC	SC100100RC
1050 x 1050	SC105105LL	SC105105RR	SC105105LC	SC105105RC
1100 x 900	SC11090LL	SC11090RR	SC11090LC	SC11090RC
1100 x 1000	SC110100LL	SC110100RR	SC110100LC	SC110100RC
1100 x 1100	SC110110LL	SC110110RR	SC110110LC	SC110110RC
1200 x 900	SC12090LL	SC12090RR	SC12090LC	SC12090RC
1250 x 950	SC12595LL	SC12595RR	SC12595LC	SC12095RC
1200 x 1000	SC120100LL	SC120100RR	SC120100LC	SC120100RC
1200 x 1200	SC120120LL	SC120120RR	SC120120LC	SC120120RC
1400 x 900	SC14090LL	SC14090RR	SC14090LC	SC14090RC
1400 x 1000	SC140100LL	SC140100RR	SC140100LC	SC140100RC
1500 x 900	SC15090LL	SC15090RR	SC15090LC	SC15090RC
1500 x 1000	SC150100LL	SC150100RR	SC150100LC	SC150100RC
1600 x 900	SC16090LL	SC16090RR	SC16090LC	SC16090RC
1600 x 1000	SC160100LL	SC160100RR	SC160100LC	SC160100RC
1800 x 900	SC18090LL	SC18090RR	SC18090LC	SC18090RC
1800 x 1000	SC180100LL	SC180100RR	SC180100LC	SC180100RC
2000 x 900	SC20090LL	SC20090RR	SC20090LC	SC20090RC
2000 x 1000	SC20090LL	SC200100RR	SC200100LC	SC200100RC

GLASS THICKNESS: 10mm

GLASS HEIGHT: 2000mm. Custom Height Optional

DOOR WIDTH: 600, 650, 700mm or as required

DOOR POSITION: Centred or Off-Centre as shown

Sliding Door options not shown -- contact Impresa for details

WASTE OUTLET POSITION

Standard: Rear corner or centre.

Custom position optional

Corner Tray: Left-Hand

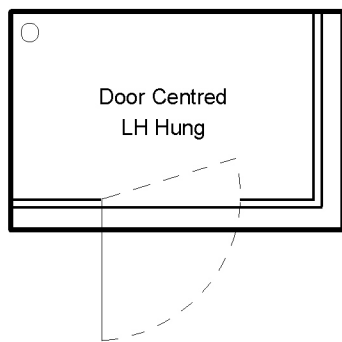

Enclosure A

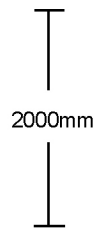
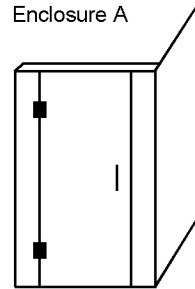

Enclosure B

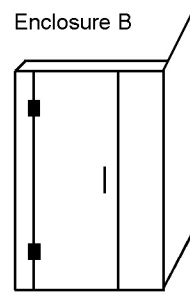

Corner Tray: Left-Hand

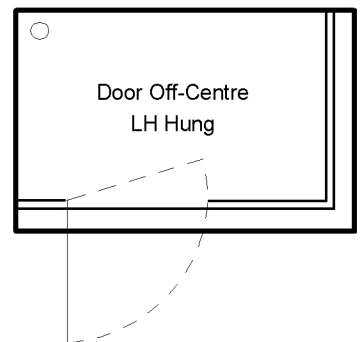

Corner Tray: Left-Hand

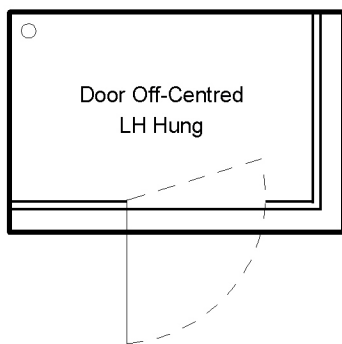

Enclosure C

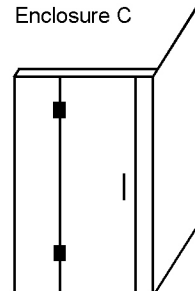

Enclosure D

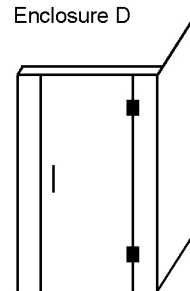

Corner Tray: Left-Hand

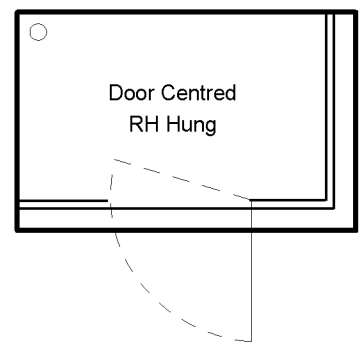

Corner Tray: Left-Hand

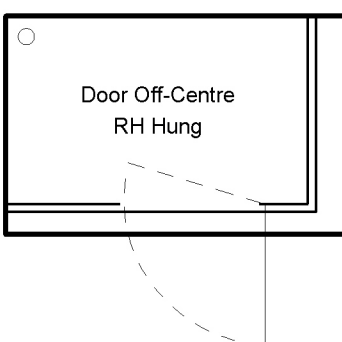

Enclosure E

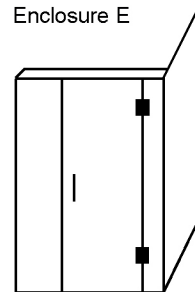

Enclosure F

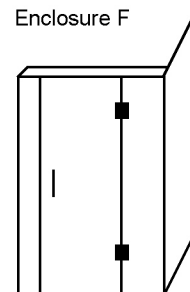

Corner Tray: Left-Hand

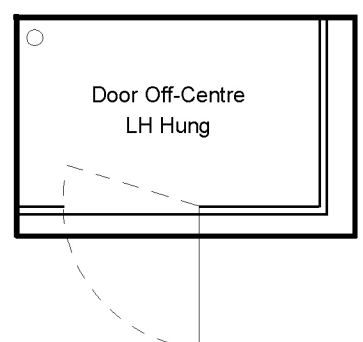

GLASS THICKNESS: 10mm

GLASS HEIGHT: 2000mm. Custom Height Optional

DOOR WIDTH: 600, 650, 700mm or as required

DOOR POSITION: Centred or Off-Centre as shown

Sliding Door options not shown -- contact Impresa for details

WASTE OUTLET POSITION

Standard: Rear corner or centre.

Custom position optional

Corner Tray: Right-Hand

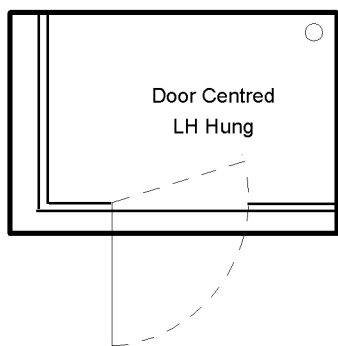

Enclosure G

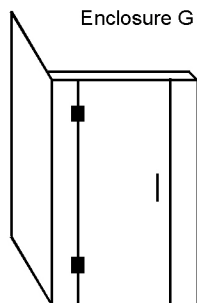

Enclosure H

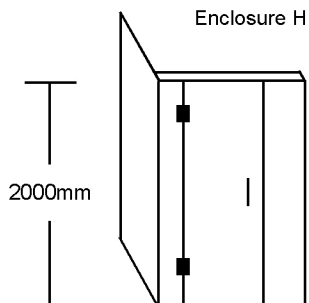

2000mm

Corner Tray: Right-Hand

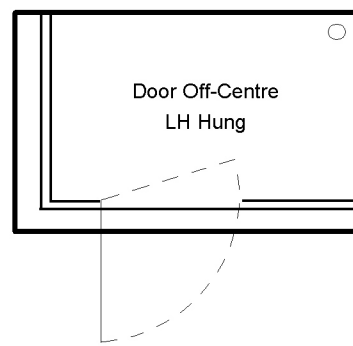

Corner Tray: Right-Hand

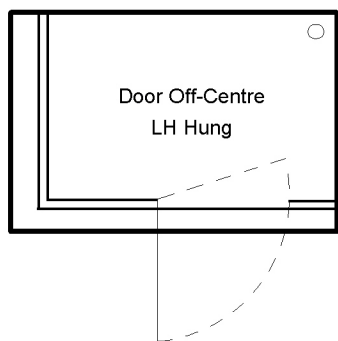

Enclosure I

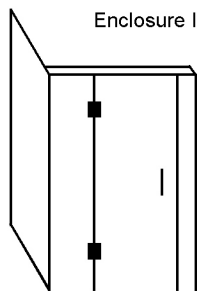

Enclosure J

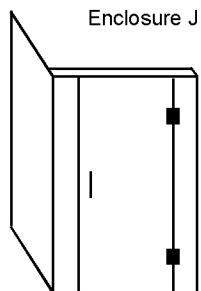

Corner Tray: Right-Hand

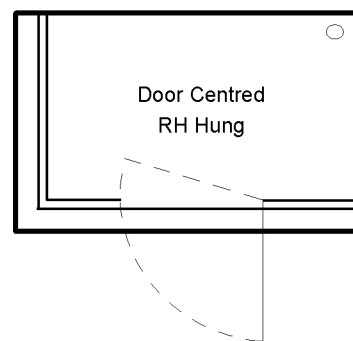

Corner Tray: Right-Hand

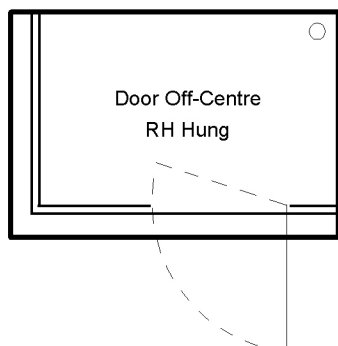

Enclosure K

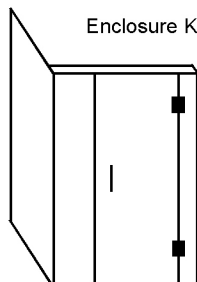

Enclosure L

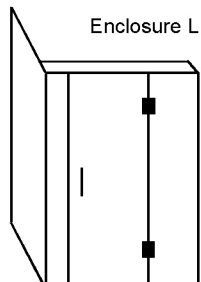

Corner Tray: Right-Hand

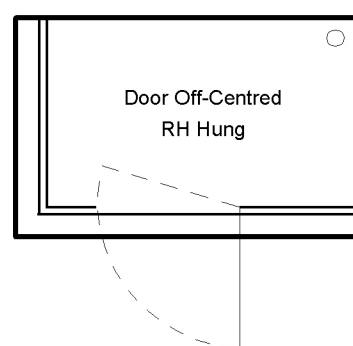

GLASS THICKNESS: 10mm

GLASS HEIGHT: 2000mm. Custom Height Optional

DOOR WIDTH: 600, 650, 700mm or as required

DOOR POSITION: Centred or Off-Centre as shown

Sliding Door options not shown -- contact Impresa for details

WASTE OUTLET POSITION

Standard: Rear corner or centre.

Custom position optional

Corner Tray: Left-Hand

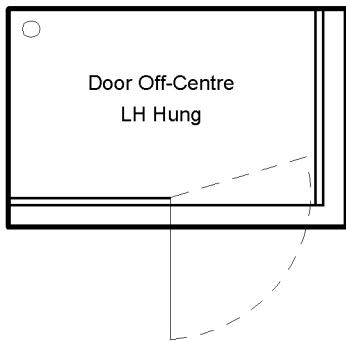

Enclosure M

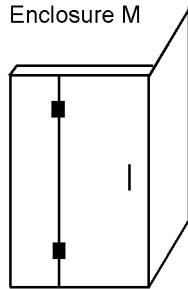

Enclosure N

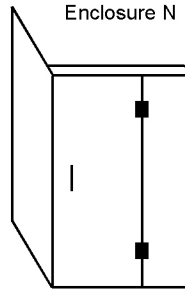

Corner Tray: Right-Hand

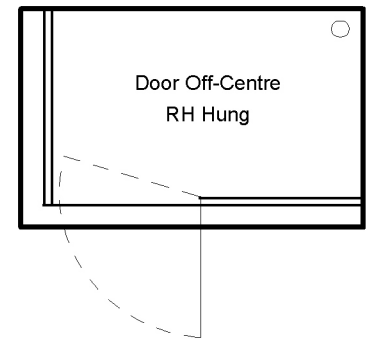

Corner Tray: Left-Hand

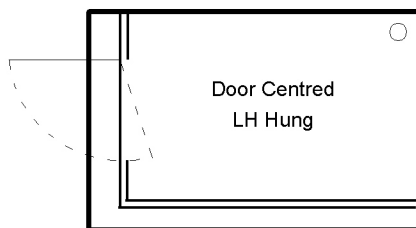

Enclosure A

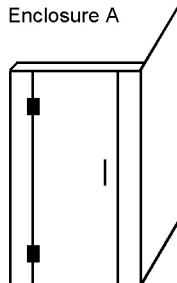

Enclosure J

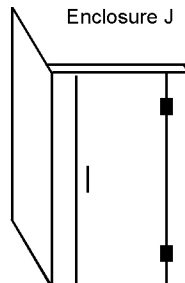

Corner Tray: Right-Hand

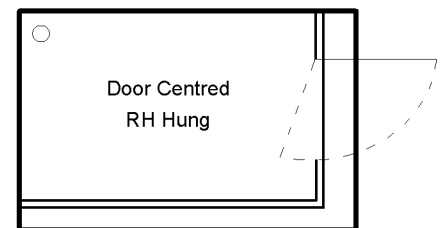

WALK-THRU' SHOWER

Glass Thickness: 10mm.

Glass Height: 2000mm. Custom Height Optional

Walk-Thru Opening Width: 600-800mm

WASTE OUTLET POSITION

Standard: Rear corner or centre.

Custom position optional

Corner Tray: Left-Hand

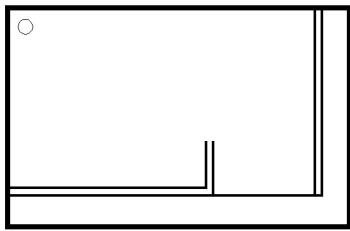

Enclosure 3PL

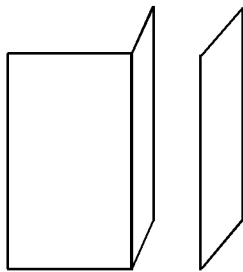

Enclosure 3PR

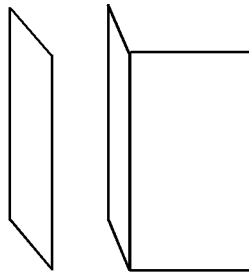

Corner Tray: Right-Hand

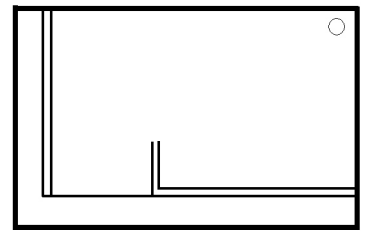

Corner Tray: Left-Hand

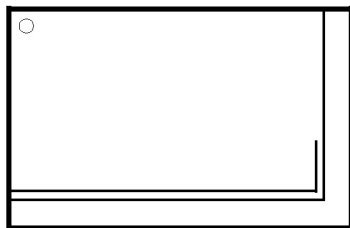

Enclosure: 2PL

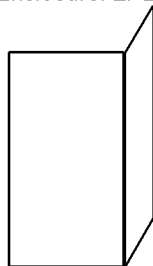

Enclosure 2PR

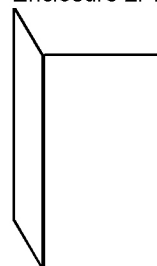

Corner Tray: Right-Hand

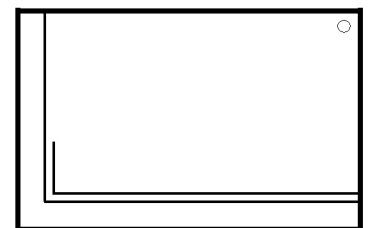

Corner Tray: Right-Hand

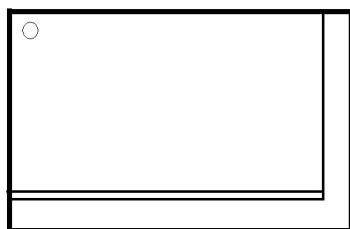

Enclosure PL

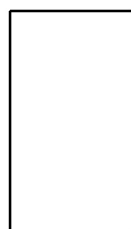

Enclosure PR



Corner Tray: Left-Hand

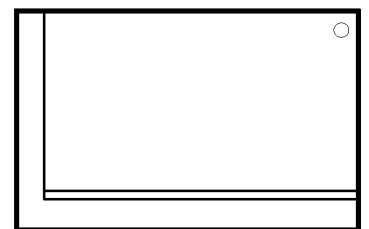

SQUARE TRAY AND GLASS ENCLOSURES

GLASS THICKNESS: 10mm

GLASS HEIGHT: 2000mm. Custom Height Optional

DOOR WIDTH: 600, 650, 700mm or as required

DOOR POSITION: Centred or Off-Centre as shown

WASTE OUTLET POSITION

Standard: Rear corner or centre.

Custom position optional

Square Tray: Left-Hand

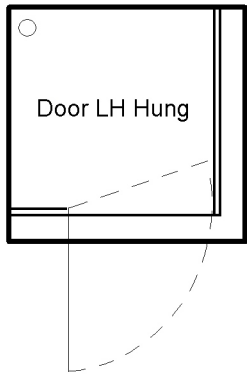

Enclosure M

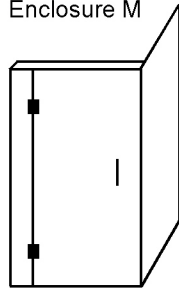

Enclosure N

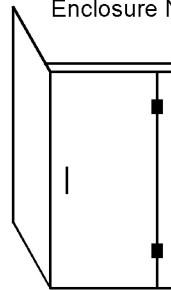

Square Tray: Right-Hand

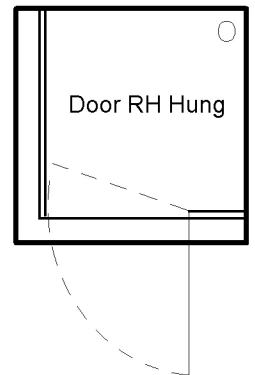

Square Tray: Left-Hand

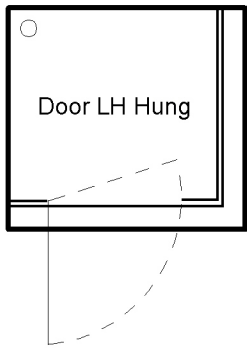

Enclosure A

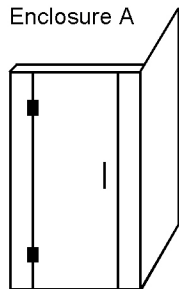

Enclosure J

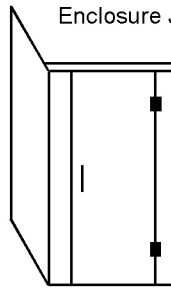

Square Tray: Right-Hand

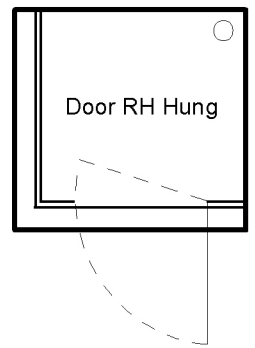

Square Tray: Left-Hand

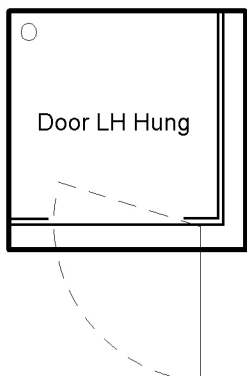

Enclosure D

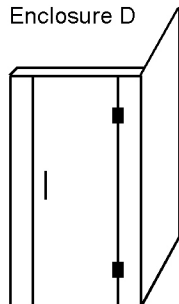

Enclosure G

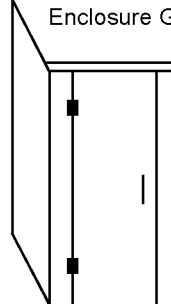

Square Tray: Right-Hand

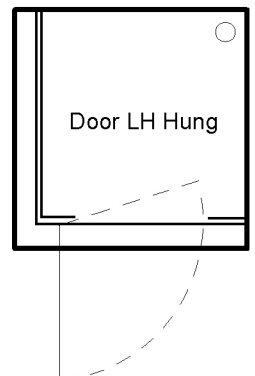



STANDARD SIZES LIST



angle shower



ANGLE TRAY STANDARD SIZES

TRAY OPTIONS

(A) 'On-Floor' with Threshold

(B) 'Level - Entry' with Step

(C) 'Wheelchair-Access' Flush-Entry

GLASS ENCLOSURES

See Tray and Glass Enclosure page

ORDERING STANDARD SIZES

Provide code number of required tray size / waste-outlet position for On-Floor / Level-Entry trays.

Add 'W' for Wheelchair tray option.

TRAY SIZE	REAR WASTE CODE NO.	CENTRE WASTE CODE NO.
900 x 900	ST9090R	ST9090C
950 x 950	ST9595R	ST9595C
1050 x 1050	ST105105R	ST105105C
1000 x 1000	ST100100R	ST100100C
1100 x 1100	ST110110R	ST110110C
1200 x 1200	ST120120R	ST120120C

ANGLE TRAY AND GLASS ENCLOSURES

GLASS THICKNESS: 10mm

GLASS HEIGHT: 2000mm. Custom Height Optional

DOOR WIDTH: 600, 650mm or custom

DOOR POSITION: Centred or Off-Centre as shown

WASTE OUTLET POSITION

Standard: Rear corner or centre.

Custom position optional

Angle Tray: Left Hand

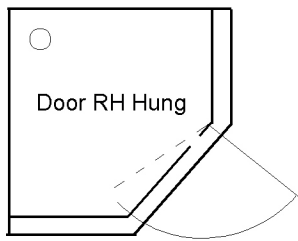

Enclosure Y

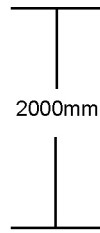
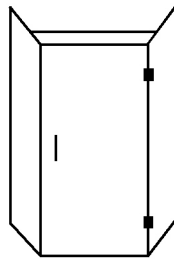

Enclosure Z

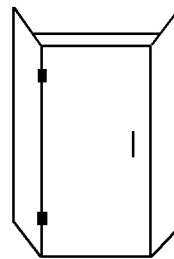

Angle Tray: Right Hand

